

**TOUCH SCREEN INTERACTIVE WHITEBOARD**

# **Instruction Manual**

Before using the machine, please read the instruction manual carefully and operate the machine correctly on the basis of having full understanding. The pictures in the instruction manual are for reference only. Please refer to the physical product if there is any inconformity.

## Safety warning

### 1. Placement

Please do not place the machine in an unstable place which is easy to incline or fall.  
Please do not place the machine in a place with direct sunshine or close to the strong light source.  
Please do not place the machine close to the equipment with strong radiation.  
Please do not place the machine in a wet site or any other site with liquid spatter.  
Please do not insert any object into the inner machine.  
Please do not place any heavy object on the machine.

### 2. Power source

Please inspect and maintain the voltage value on the nameplate of the back shell to be matched with the main supply voltage.  
In storm and lightning days, please pull off the power wire and antenna plug.  
Please pull off the power plug if the operation room has no person or the machine will not be operated for a long period.  
Please avoid physical or mechanical destruction of the power wire.  
Please use the specialized power wire. It is forbidden to change or prolong the power wire.  
Before operation, please inspect and maintain the AC power cord is grounding connected.  
The power wire equipped to the machine is only suitable for the interactive all-in-one machine. It is forbidden to use it for any other machine.

### 3. Screen

Please do not use any rigid or sharp object to write on the screen.  
Please pull off the power plug in the first when the screen is to be cleaned.  
Please wipe the screen with the soft, dust-free and dry cloth.  
Please do not wash the machine with water or spray-type detergent.  
Please do not keep the luminance to the maximum for a long period.

### 4. Temperature

Please do not place the machine near the electric warming oven, heating sheet or other heating devices or other heating sources.  
When the machine is moved from the low-temperature area to the high-temperature area, please avoid the sufficient emission of the moisture condensation in the machine. Please place the machine for a while before electrifying and operating the machine. The normal working temperature of the machine is 0-40°C.

### 5. Humidity

Please do not expose the machine in the rain, wet environment or any other place near water.  
Please maintain the coolness and dryness in the machine. The normal working humidity of the machine is 10%-90%.

### 6. Ventilation

Please keep the machine in a ventilated place, ensuring the sound heat dissipation of the machine.  
The left, right and back sides of the machine should be left with spaces of 10cm for ventilation while the top space should be over 20cm.



## 7. Earphone

If the earphone is used to listen to the noisy sound for a long period, the hearing sense will be influenced. If it is required to connect with the earphone, please lower down the machine sound in advance.

## 8. Standby

Pressing the ECO button on the machine will not turn off the machine, instead the machine will in the standby mode.

## 9. Battery

The obsolete battery should be handled and recovered correctly.

Please keep the children away from the battery and avoid putting the battery in fire, so as to avoid hazard.

## 10. Cleaning requirement





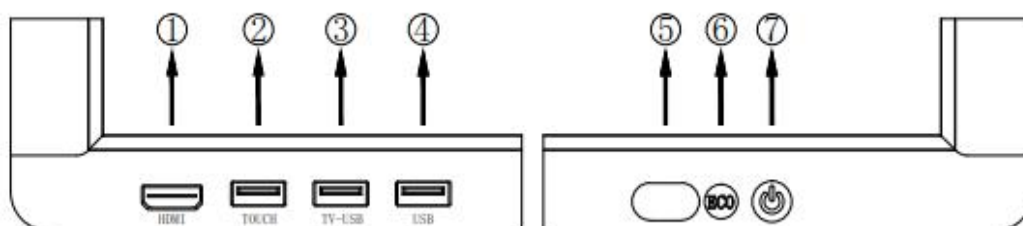

The back shell of the product has heat dissipation holes. Please do not spray and pour liquids to the back shell in cleaning. It is also forbidden to be cleaned with the wet cloth.

## 11. Attentions in maintaining

In case the equipment has any damage, such as the damage of the power wire or plug, having liquid spatter into the inner machine, having any object drop into the machine, the equipment is wet, moisturized or unable to operate normally, please contact us. The technical engineers of the original plant will repair the machine.









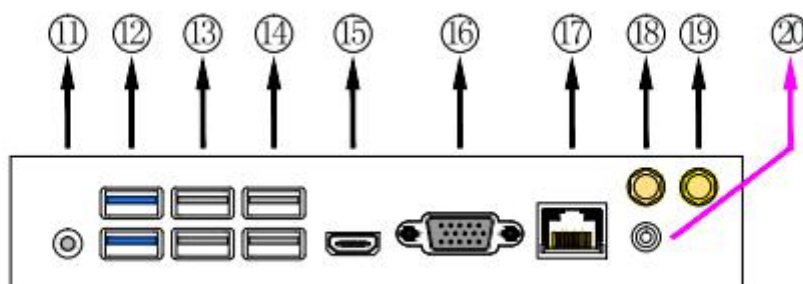
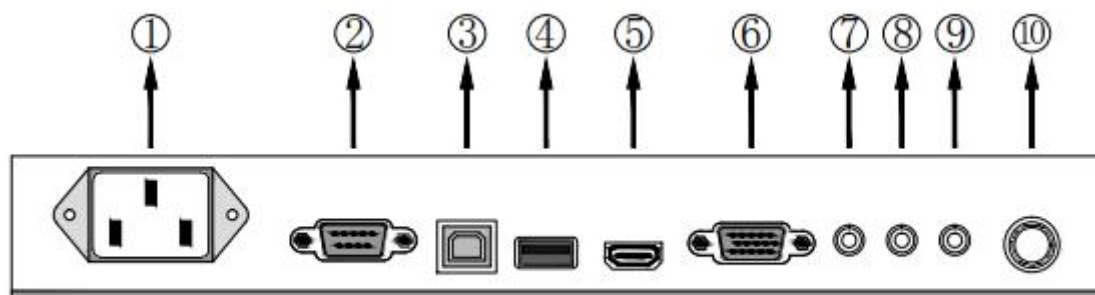





## Preposed interfaces









Item	Function description
① 	Preposed high-definition interface
② 	External touch interface, matched with HDMI
③ 	Multi-media USB socket, firmware upgrade port
④ 	Preposed USB interface of the computer
⑤ 	Window of receiving remote signal, built-in LED indicating light
⑥ 	Energy-saving standby button
⑦ 	One-key switch machine, pressing to turn on or tun off the machine

## Terminal interfaces



Item	Function description
① 	AC power input of the entire machine
② 	Serial communication interface
③ 	Touch USB interface of the external equipment
④ 	Multi-media USB socket, firmware upgrade port
⑤ 	HDMI interface, connect with the computer, set-top box and other devices with HDMI input
⑥ 	Connect with the device with VGA output function
⑦ 	VGA audio input
⑧ 	AV input, compound video, audio input
⑨ 	Earphone output
⑩ 	Digital integrated TV interface
⑪ 	Button of turning on and turning off the computer
⑫ 	USB3.0 interface, connect with USB3.0 interface, such as the mobile disk, USB, USB mouse and so on
⑬ 	USB2.0 interface, connect with USB interface, such as the mobile disk, USB, USB mouse and so on
⑭ 	USB2.0 interface, connect with USB interface, such as the mobile disk, USB, USB mouse and so on

⑮		Connect with the display equipment with HDMI input function
⑯		Connect with the display equipment with VGA input function
⑰		Network interface, connect RJ45 port to the Internet (this interface is only used on computer systems).
⑱		WIFI antenna interface
⑲		WIFI antenna interface
⑳		Audio input/output interface, insert into the corresponding terminals in the computer

## Remote control

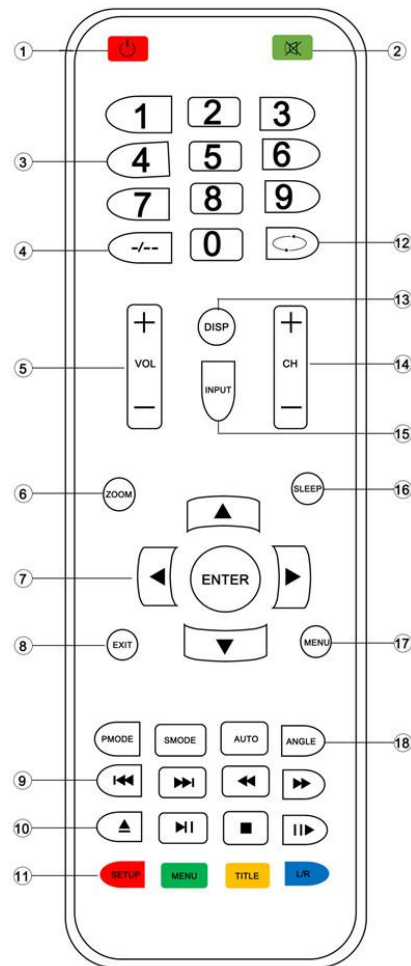

- 1) Power: power switch of the display screen.
- 2) Mute: Mute button, press this button once to have no sound of the trumpet, press again to unmute.
- 3) Number key: integrated channel short-cut key, can select the program within 0-9.
- 4) -/-- : can choose the favored channel under TV mode with this key.
- 5) Volume+/-: press this key to choose different volumes according to the favor.
- 6) Zoom: press this key to zoom the photo.

- 7) ▲/▼/◀/▶/ENTER: direction key of the all-in-one machine, press this key to select in the upper, lower, left and right directions and press “ENTER” key for confirmation.
- 8) Exit: press the key to exit from the present status.
- 9) ◀◀/▶▶/◀◀◀/▶▶▶ : control keys of fast backward, fast forward, last music and next music.
- 10) ▲ / ▶| / ■ / ||▶ : play/pause, stop control keys.
- 11) SETUP/MENU/TITLE/L/R: function key in channel editing.
- 12) ↻: channel return key of the all-in-one machine, press this key to go back to the channel watched previously.
- 13) DISP: press this key to display the present status information.
- 14) Channel +/-: press this key to select the last and next programs.
- 15) INPUT: signal source selection key, choose different signal sources as demands, and press the confirm key for confirmation.
- 16) Sleep: turn off the machine in fixed time. The user can choose different time of turning off the machine according to the favor.
- 17) Menu: press this key to pop out the OSD menu key of the TV.
- 18) PMODE/SMODE/AUTO/ANGLE: function key in channel editing  
 PMODE: press this key to choose different image models.  
 SMODE: press this key to choose different sound models.  
 AUTO: pressing this key to adjust the display scale automatically.  
 ANGLE: the button of image display scale, press this key to switch different image display scales.

## Operation instruction of the remote control.

### Battery installation:

1. Open the back cover of the battery component at the back of the remote control;
2. Load the battery of model AAA according to the corresponding the electrode, ensure the placed battery has correct polarity(“+” to “+”, “-” to “-”). Please do not mix the new and old batteries;
3. After installing the battery, please close the back cover of the battery component. The below snap joint will be clamped to the bottom.

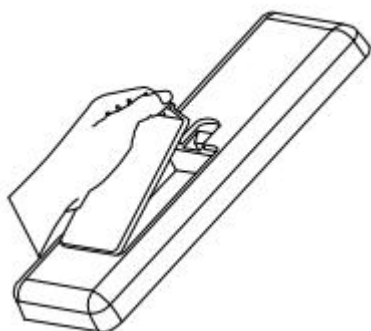

Open the back cover

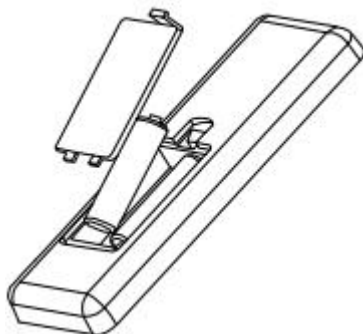

Load AAA battery

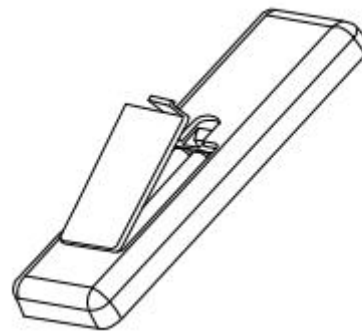

Close the battery cover

## Remote control scope:

The remote control can be used in the scope of within 8 meters to the all-in-one machine and 30° in the left and right sides.

! **Attention:** Using the battery of wrong models will be at the risk of explosion. In order to protect the environment, please put the obsolete battery into the recycling bins.

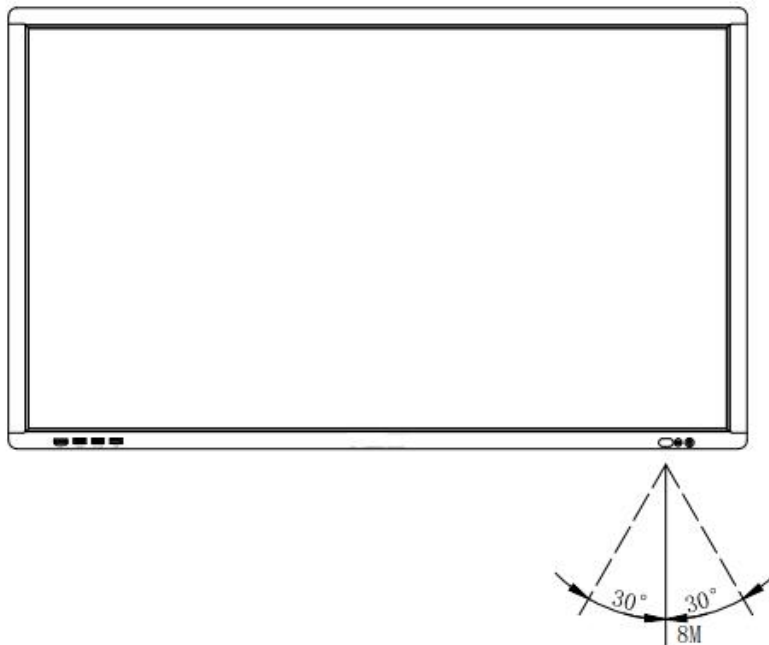

## Menu operation

### 1. Humanized touch operation menu

Pull up the menu by gesture, place the touch pen in the lowest part of the display area and then pull upwards, the signal source, image, sound, setting, screen and other shortcuts can be deployed.

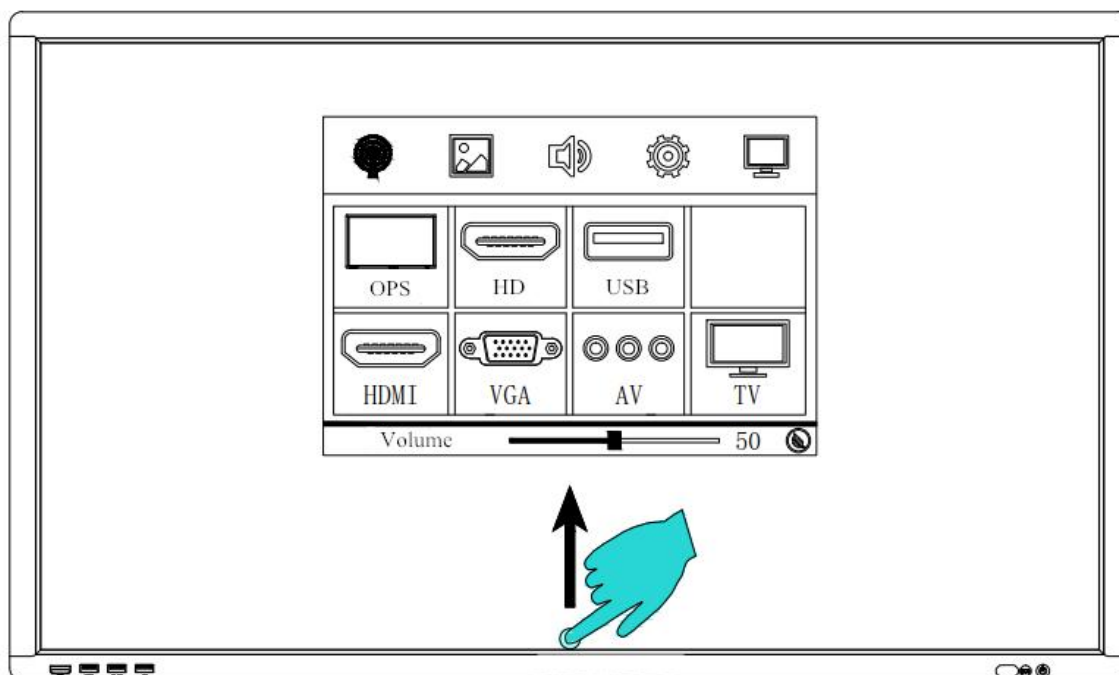

## 2. Gesture menu

The bottom part of the menu is the volume adjustment.

The “tree leaf” symbol and the “ECO” button in the bottom part of the menu are energy-saving and electricity-saving.



### A. Signal channel option

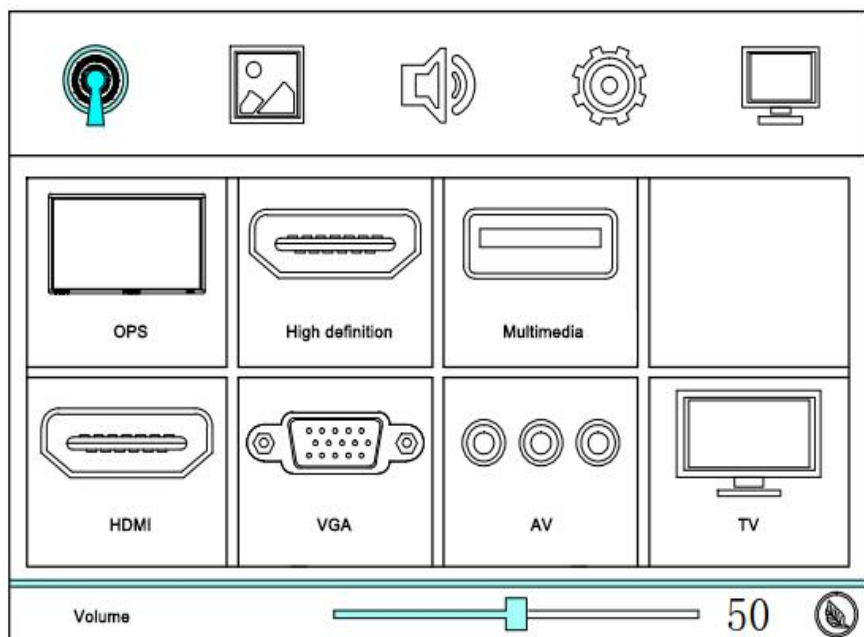

Signal channel option

1	Computer signal of the machine
2	Preposed high-definition signal
3	Preposed TV-USB signal
4	Rear high-definition signal
5	Rear VGA signal
6	Rear AV signal
7	Rear analog signal

### B. Image menu

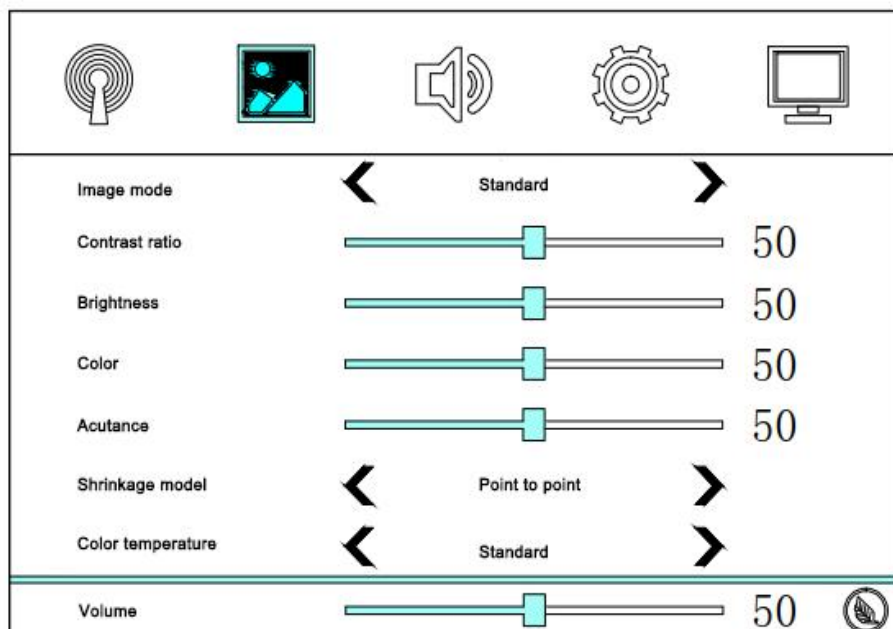
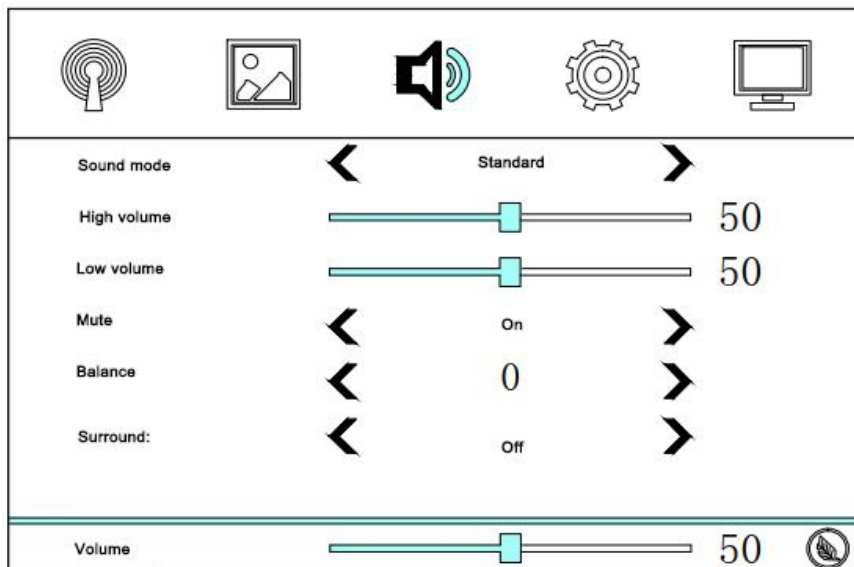

Image menu

1	Select image display mode
2	Adjust image contrast ratio
3	Adjust image brightness
4	Adjust image color
5	Adjust image acutance
6	Adjust display scale
7	Select color temperature mode



### C. Volume mode



Sound menu	
1	Select sound mode
2	Adjust high volume
3	Adjust low volume
4	Mute switch
5	Adjust the volume balance of the left and right sound tracks
6	Acoustics mode switch

### D. Setting menu

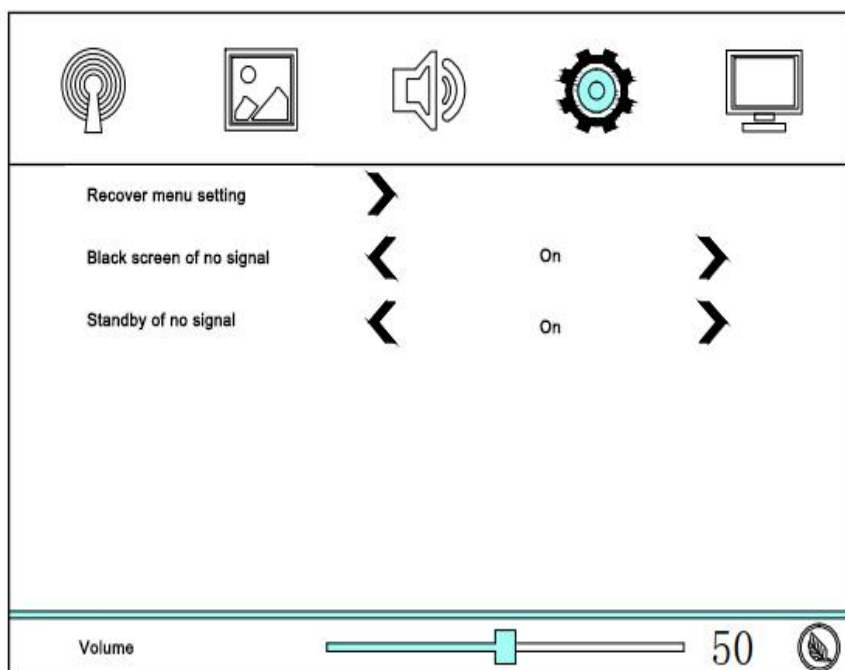

Setting menu	
1	Recover factory setting
2	"ON" is the black screen of no signal
3	"ON" is the standby mode of no signal

## E. Function men

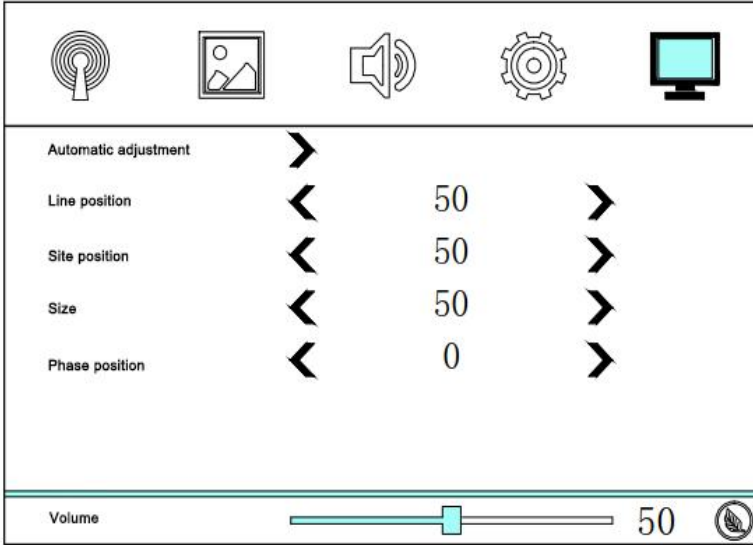

Function menu	
1	Correct the full screen of the screen under VGA channel
2	Adjust to display the horizontal position
3	Adjust to display the vertical position
4	Adjust the horizontal shrinkage of the screen
5	Adjust the phase position

## Installation and setting

! For the safety of the operator and machine, please do not connect with any power plug before the external equipment is finished the installation.

### 1. Connection of the external computer and touch screen.

#### A. HDMI terminal connection

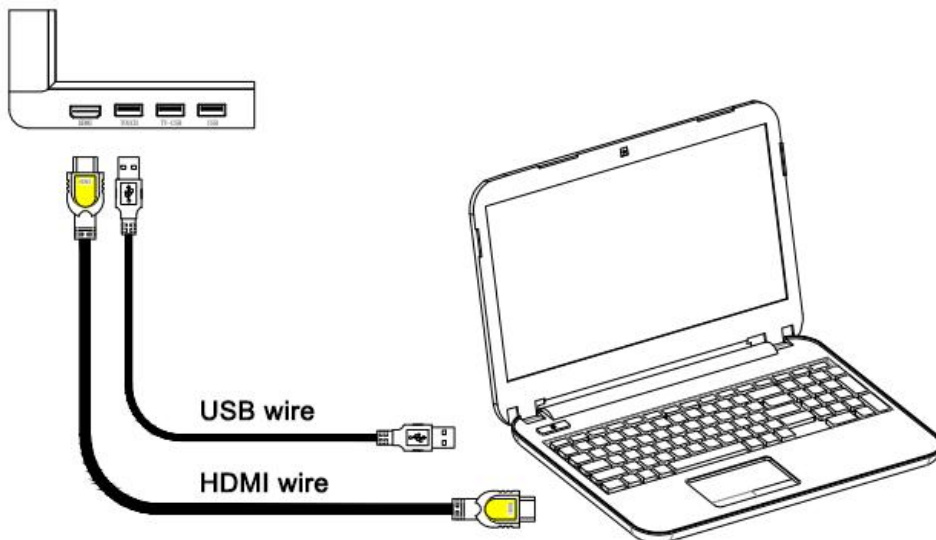

1. Connect with the HDMI output terminal of the external computer with HDMI connecting wire(All-in-one machine will skip the signal source on recognizing the signal).
2. Connect with the USB interface of the external computer with the USB connecting wire.

! **Attention:** Connect with HDMI signal. The all-in-one machine with high configuration has the highest resolution ratio of 3820\*\*2160 while the normal machine has the highest resolution of 1920\*1080.

## B. VGA terminal connection

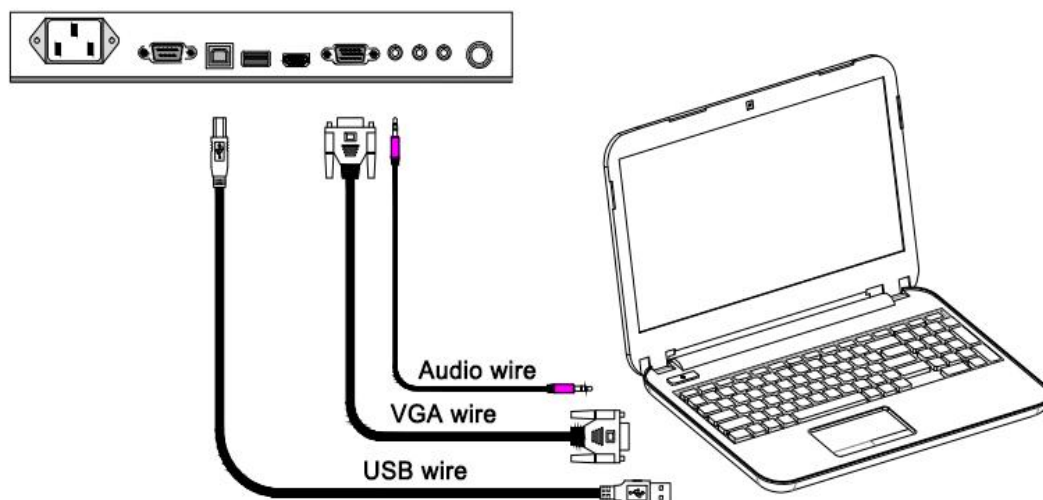

1. Connect with the VGA terminal of the external computer with VGA wire, and connect with the audio output interface of the external computer with the audio wire at the same time(All-in-one machine will skip the signal source on recognizing the signal).
2. Connect with the USB interface of the external computer with USB square-opening connecting wire.
3. Set "screen resolution ratio"-the display mode is "duplicate the desktop".

! **Attention:** connect with the all-in-one machine with VGA. The best resolution ratio of the machine is 1920\*1080.

## C. Antenna connection

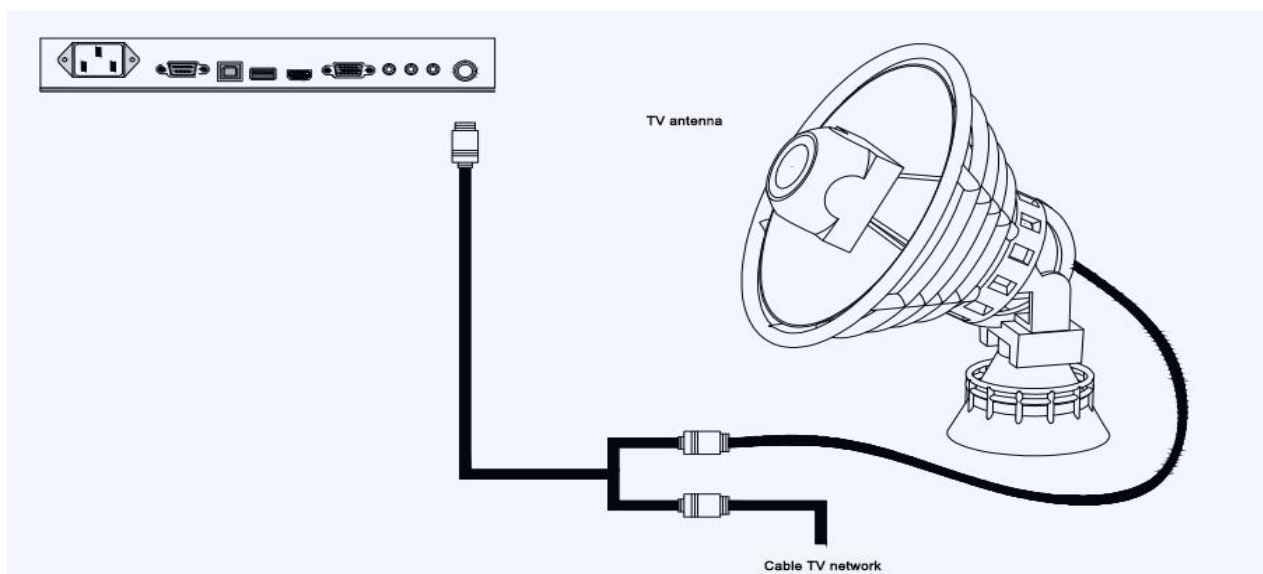

1. Connect with the cable TV interface with RF wire.
2. Switch to TV channel with the remote control(please refer to the menu operation for the touch gesture).

## D. Audio and video device.

### 1. AV IN

- A. Connect audio and video equipment with AV output with AV audio and video cable (yellow is video, red is right channel, white is left channel)
- B. Switch to AV channel with the remote control (please refer to the menu operation for the touch gesture)

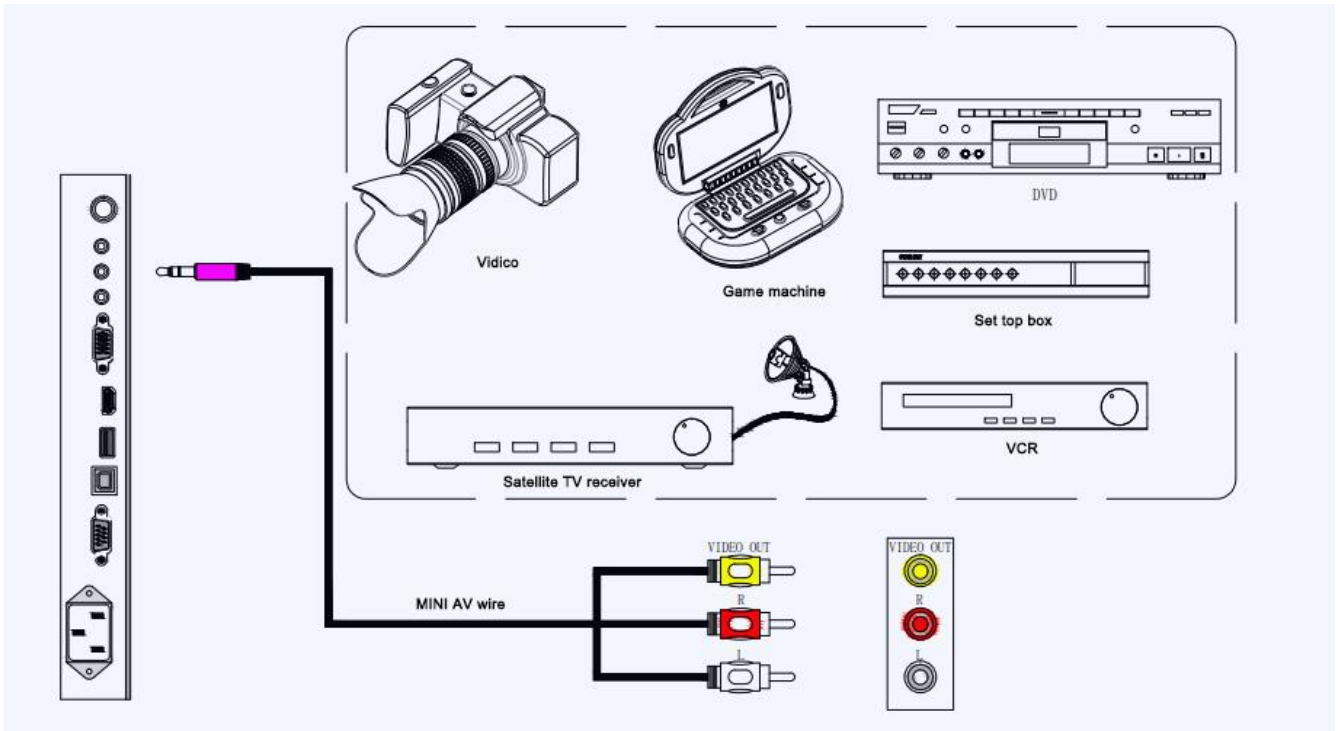

### 2. HDMI

- A. Connect an audio device with an HDMI output with an HDMI cable
- B. Switch to HDMI channel with the remote control (please switch to the high-definition channel if the proposed high-definition interface is inserted. In such condition, please refer to the menu operation for the touch gesture).

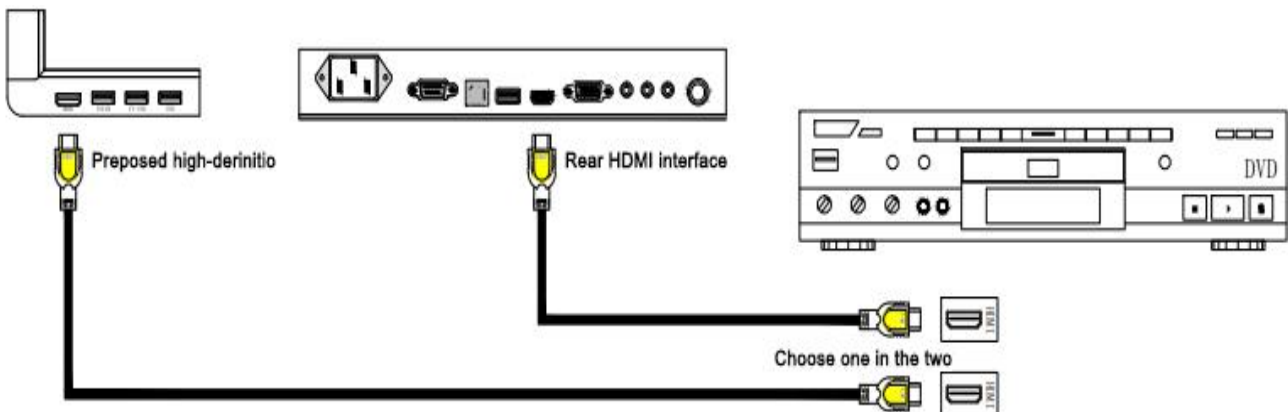

### 3. Video output connection.

- A. Connect with the video device with VGA input with VGA wire
- B. Switch to VGA channel with the remote control (please refer to the menu operation for the touch gesture)
- C. If it is required to have synchronous display of the all-in-one machine and external VGA, it is required to set the "screen resolution ratio"-the display mode is "duplicate the desktop".



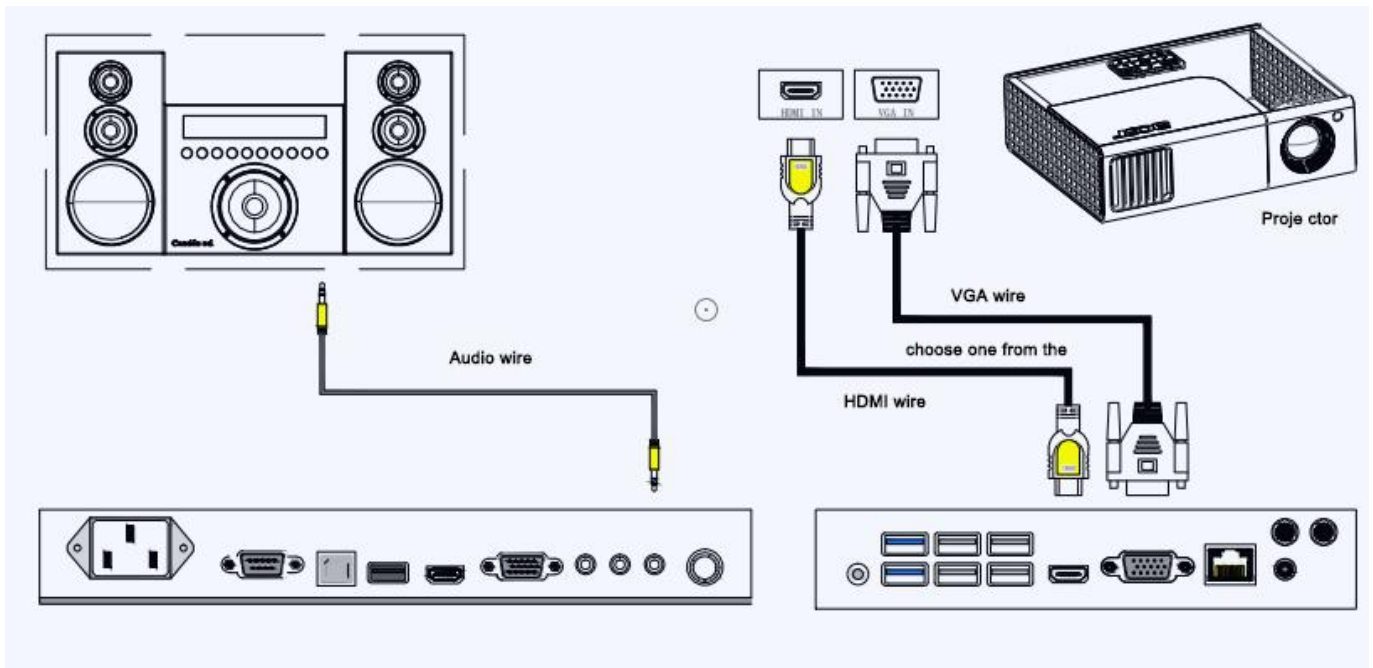

#### 4. Connections of USB device, network cable and microphone

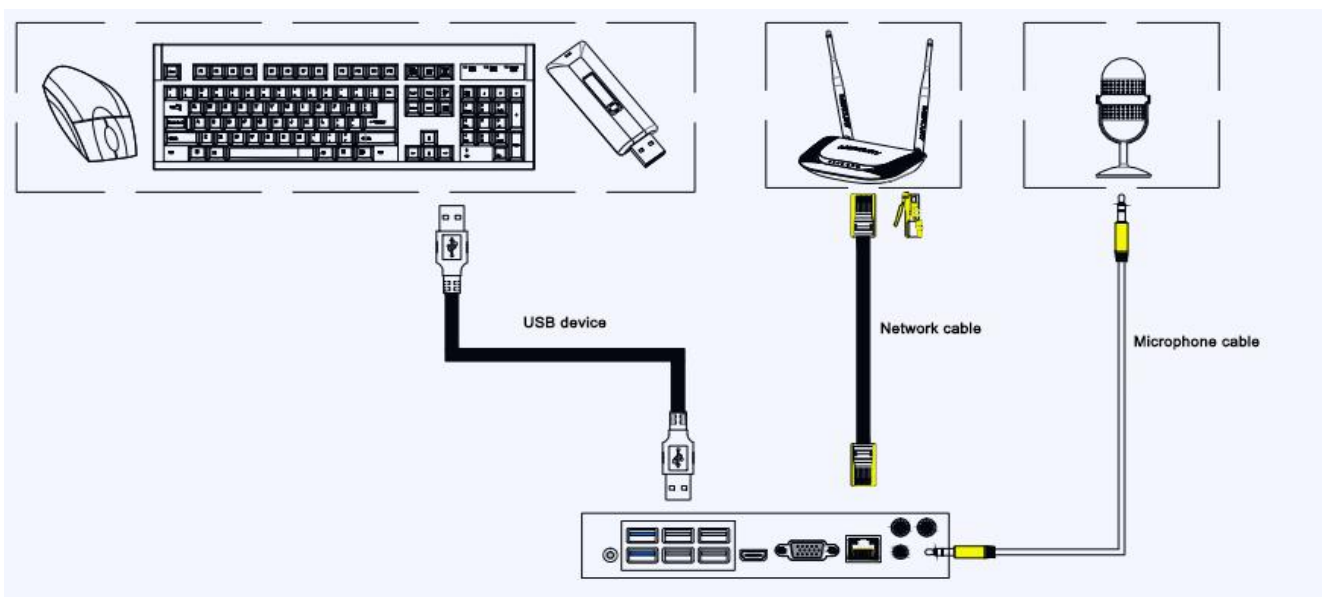

### An introduction of the touch means

Single click: Tap the screen with the touch pen and lift the touch pen

Double click: Use the touch pen to tap the screen twice (with an interval of about 0.5 seconds), then lift the touch pen

Right key: Touch the screen with the touch pen for 1-3 seconds, lift the touch pen when the circle appears

Drag: Use the touch pen to hold down the icon you want to drag, press and hold the touch pen to the target position, then lift the touch pen

Slide: Use the touch pen to press on the slide interface (such as the slide bar of web browsing), and drag the touch pen in the direction in sliding needs. When the touch pen leaves the screen during the dragging process, the drag ends.

Shrinkage: Use a touch pen to hold down the shrinkable interface (such as web pages, images, etc.), and the other touch pen moves to the center of the two pens.

# Hanging bar

After hanging the all-in-one machine, the double locks will be closed automatically under gravity to lock the wall.

If it is required to unload the all-in-one machine, it is only required to pull the green pull line. The double latch hook will be opened because of the tension.

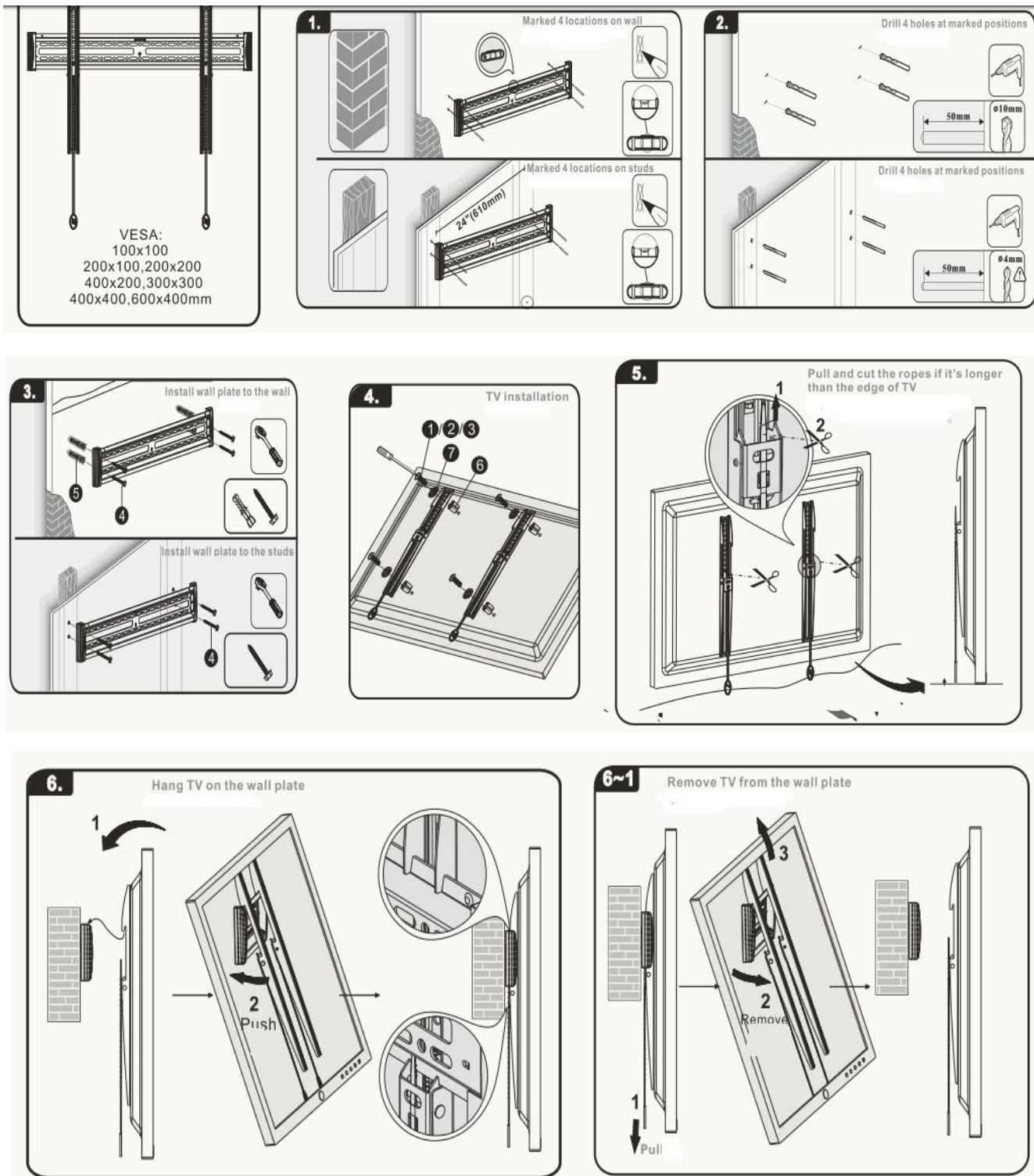

## **FQA ( questions and answers):**

### 1. Why does the screen have mist?

In order to ensure the safety of the screen, a layer of tempered glass is added on the outside of the screen. Moreover, in order to ensure heat dissipation, there is a certain gap between the two, which is used to reserve the air passage for air convection. The main reason for the fog lies in the temperature difference between the screen temperature and the external temperature. The hot air condenses the water mist on the cold glass surface. The water mist does not affect the normal operation of the machine. Generally, the mist will disappear slowly after the machine has been used for several hours.

### 2. Why do the equipment in different classrooms have different start-up speeds?

It is required to confirm the reasons for this. In theory, the start-up speed is the same for the machines with the same configuration. Generally, if the machine is connected with USB, the equipment is using online, or the space of the hard disk is occupied, or the system is destroyed, the start-up speed will be slowed. You can call us directly if you have any specific problem, we will have professional engineers for judgment and guidance in solving the problem.

### 3. Why can't some devices be used in several points?

First of all, XP system doesn't support multi-point touch. If it is a WIN7 system, it is necessary to install a home advanced version (WINDOWS 7 Home Premium) or above to support multi-point touch regardless of the external computer or the built-in computer. Microsoft WIN7 has released 2 types and 6 versions (WINDOWS 7 Starter ,WINDOWS 7 Home Basic Home Edition, WINDOWS 7 Home Premium Home Premium, WINDOWS 7 Professional Professional, WINDOWS 7 Enterprise Enterprise Edition).

### 4. The externally connected laptop has no sound.

If it is VGA wire connection, it is only the image transmission. It is required to connect with the audio wire, only the connection of audio wire also has no sound.

If it is HDMI wire connection, it is required to set the "broadcast device" and set the "high-definition audio equipment" as the default value.

### 5. After using for a period, the screen becomes hot. Is it a normal phenomenon? Does it have any influence?

Screen heating is a normal phenomenon and will not have adverse effects. At present, our machine heat dissipation meets international health standards.

## Simple fault elimination

Malfunction of the remote control:

Check if there is any other obstruction between the remote control and the tablet remote control reception;  
Check if the battery polarity in the remote control is correct;  
Check if it is required to replace the battery in the remote control.

Abnormality of the start-up:

### 1. Automatic start-up.

Does it start the sleep function?

Inspect the channel of input source. If there is no signal, it will turn off automatically.

Check the power stability.

### 2. The indicating light is off.

Check if the power supply is normal

### 3. The indicating light is red and the machine can not be started.

If the channel remote control can not be turned on, check if the remote control is intact.

If the machine can not be turned on with the button, please pull off all externally connected cables. After disconnecting the electricity for 15 minutes, the machine can be started once again.

Abnormal function of the computer:

It displays back screen and has no signal after starting the machine.

If the all-in-one computer comes with a computer, check if the current channel is a built-in computer channel.

If it is connected with the computer

Check if the located channel is correct or not

Check if the wire connection is connect and if the cable is sound.

Connect with the external computer, change the shrinkage scale of the remote control in the menu into "point to point".

Abnormal sound function:

Adjust the volume by touching the menu.

Once it is connected with the computer, check if the audio cable is connected correctly.

Sett the high definition audio device to the default value in HDMI mode.

Abnormal touch function:

### 1. Incorrect touch position.

Check if the touch correction is properly installed and repositioned;

Check if the touch pen or finger touches the screen 90 degrees vertically;

Check if there are other items touching the screen, such as small paper or sleeves.

### 2. Null touch function

If the all-in-one computer is connected to the computer, check if the infrared touch cable is properly connected.